

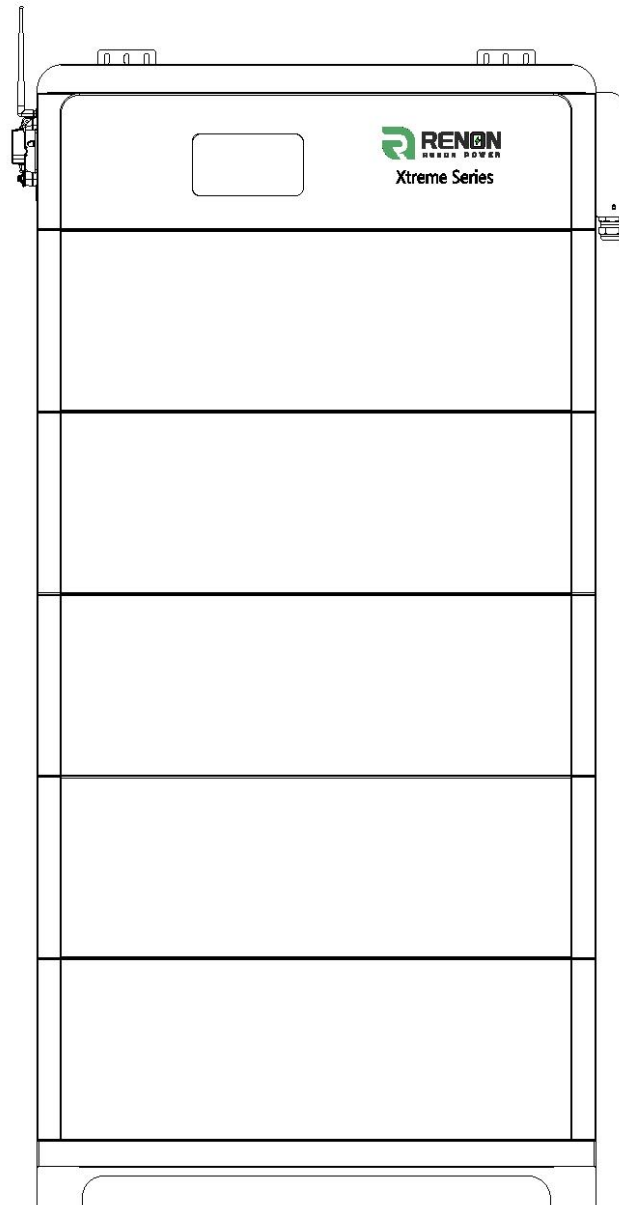

User Manual of Xtreme HV Series



Email: support@renonpower.com

Official website: www.renonpower.com

Address: 5900 Balcones Drive STE 100, Austin, TX 78731, United States



Revision History

| Ver. | Date | Revise contents | Reviser |
|------|------------|-----------------|---------|
| A0 | 2023.07.18 | New Edition | Cooper |
| | | | |
| | | | |
| | | | |
| | | | |
| | | | |
| | | | |
| | | | |
| | | | |
| | | | |
| | | | |
| | | | |
| | | | |
| | | | |
| | | | |



Table of Contents

| | | |
|--------|---|----|
| 1 | Safety Instructions | 5 |
| 1.1 | General Safety Precautions | 5 |
| 1.2 | Transportation and Storage Precautions | 6 |
| 1.3 | Installation Precautions | 7 |
| 1.4 | Usage Precautions | 7 |
| 1.5 | Response to Emergency Situations | 8 |
| 1.6 | Qualified Personnel | 9 |
| 2 | Introduction | 10 |
| 2.1 | Product features | 10 |
| 2.2 | Specifications | 11 |
| 2.3 | Interface Information | 12 |
| 2.3.1 | Power Positive | 13 |
| 2.3.2 | Power Negative | 13 |
| 2.3.3 | Inverter Dial Switch | 13 |
| 2.3.4 | Address Dial Switch | 14 |
| 2.3.5 | Function Dial Switch | 14 |
| 2.3.6 | USB Port | 15 |
| 2.3.7 | Dry Contact | 15 |
| 2.3.8 | Inverter Communication Port (connector) | 15 |
| 2.3.9 | Inverter Communication Port (RJ45) | 16 |
| 2.3.10 | Debug Port | 16 |
| 2.3.11 | Link A and Link B | 17 |
| 2.3.12 | Power Switch | 17 |
| 2.3.13 | Active Switch | 17 |
| 2.3.14 | On/Off | 17 |
| 2.3.15 | WIFI Antenna | 17 |
| 3 | Installation and Usage | 18 |
| 3.1 | Safe Handling Guide | 18 |
| 3.1.1 | Familiar with the product | 18 |
| 3.1.2 | Precautions before installation | 18 |
| 3.1.3 | Tools | 18 |
| 3.1.4 | Safety Gear | 19 |
| 3.2 | System Premeasurement | 19 |



| | |
|--|----|
| 3.3 Installation location | 20 |
| 3.4 Package items | 20 |
| 3.5 Installation | 23 |
| 3.6 Connections of Cable and Power | 27 |
| 3.7 Wi-Fi Configuration | 31 |
| 4 Monitoring Screen | 36 |
| 4.1 LCD Screen Introduction | 36 |
| 4.2 SOC, SOH and Upgrading State | 36 |
| 4.3 Version and Accumulated Discharge Energy | 37 |
| 4.4 ESS status, Power, and Voltage | 37 |
| 4.5 Battery Operation Status | 37 |
| 5 Troubleshooting & Maintenance | 38 |
| 5.1 Regular maintenance | 38 |
| 5.2 Troubleshooting | 38 |
| 5.3 Warning Codes | 40 |
| 5.4 Error Codes | 41 |



1 Safety Instructions

For safety reasons, installer and user are responsible for familiarizing themselves with the contents of this document and all warnings before installation and usage.

1.1 General Safety Precautions

- Please carefully read this manual before any work is carried out on the product, and keep it located near the product for future reference.
- All installation and operation must comply with local electrical standards.
- Please ensure the electrical parameters of the product are compatible to related equipment.
- Do not open or dismantle the battery module. Electrolyte is very corrosive. In normal working conditions contact with the electrolyte is impossible. If the battery casing is damaged, do not touch the exposed electrolyte or powder because it is corrosive.
- The electronics inside the product are vulnerable to electrostatic discharge, keep it away from that.
- Do not place items or tools on the product.
- Do not damage the product by dropping, deforming, impacting, cutting.
- Keep the product away from liquid. Do not touch the product if liquid spills on it. There is a risk of electric shock.
- Do not expose the product to flammable or harsh chemicals or vapors.
- Do not paint any part of the product, include any internal or external components.
- Do not change any part of the product, especially the battery and cell.
- Besides connection under this manual, any other foreign object is prohibited to insert into any part of the product.
- The warranty claims are excluded for direct or indirect damage due to items above.
- Batteries must not be mixed with domestic or industrial waste.



- Batteries marked with the recycling symbol must be processed via a recognized recycling agency. By agreement, they may be returned to the manufacturer.

1.2 Transportation and Storage Precautions

- The batteries must be transported according to UN3480, they must be packed according to packaging requirements of Special Regulation 230 of IMDG CODE (40-20 Edition) for maritime transport, and P965 IA for air transport (SOC less than 30%). The original packaging complies with these instructions.
- If the product needs to be moved or repaired, the power must be cut off and completely shut down.
- The product must be transported in its original or equivalent package; the battery module must be placed at upright position.
- The modules are heavy. Ensure adequate and secure mounting and always use suitable handling equipment for transportation.
- If the product is in its package, use soft slings to avoid damage.
- Do not stand below the product when it is hoisted.
- During transportation, severe impact, extrusion, direct sunlight, and rain should be avoided.
- Store in a cool and dry place.
- Store the product in clean environment, free of dust, dirt, and debris.
- Store the product out of reach of children and animals.
- Don't store the battery under 50% SOC for over one month, this may result in permanent damage to the battery and void the warranty.
- If the product is stored for long time, it is required to charge the battery module every 3 months, and the SOC should be no less than 90%.



1.3 Installation Precautions

- Do not install the product in an airtight enclosure or in an area without ventilation.
- Do not install the product in living area of dwelling units or in sleeping units other than within utility closets and storage or utility spaces.
- If the Product is installed in a garage or carport, ensure there is adequate clearance from vehicles.
- While working on the product wear protective eyeglasses and clothing.
- Handle the battery wearing insulated gloves.
- Use insulated tools. Do not wear any metallic items such as watches, bracelets, etc.
- Please turn-off related circuit breakers before and during the installation to avoid electric shock.
- Do not connect any AC conductors or photovoltaic conductors directly to the battery pack. These are only to be connected to the inverter.
- Wiring must be correct, do not mistake the positive and negative cables, and ensure no short circuit with the external device.
- Over-voltages or wrong wiring could damage the battery pack and cause combustion which can be extremely dangerous.
- Make sure the product is well grounded, and comply with local specifications, the recommended grounding resistance is less than 1Ω .
- Handle with care because Li-ion Battery is sensitive to mechanical shock.

1.4 Usage Precautions

- Before starting the system, the operator should strictly check the connection terminals to ensure that the terminals are firmly connected.
- If there's a circuit breaker between battery and inverter, the breaker is supposed to be on before power on the battery.
- Do not open the product, connect, or disconnect any wires when it's working



to avoid electric shock.

- Battery needs to be recharged within 12 hours after fully discharged.
- The default temperature range over which the battery can be discharged is -4 °F (-20 °C) to 122 °F (50 °C). Frequently discharge the battery in high or low temperature may deteriorate the performance and life of the battery pack.
- The default temperature range over which the battery can be charged is 32 °F (0 °C) to 122 °F (50 °C). Frequently charge the battery in high or low temperature may deteriorate the performance and life of the battery pack.
- Do not charge or discharge a damaged battery.
- Please contact the supplier within 24 hours if there is something abnormal.

1.5 Response to Emergency Situations

- Damaged batteries are dangerous and must be handled with extreme care. They are not suitable for use and may cause danger to persons or property. If the battery pack appears to be damaged, place it in the original container and return it to an authorized dealer.
- If the battery pack is wet or submerged in water, do not allow any person access, and then contact authorized dealer for technical support.
- In case of fire, use the carbon dioxide, FM-200 or ABC dry powder fire extinguisher; if possible, move the battery pack to a safe area before it catches fire.
- If a user happens to be exposed to the internal materials of the battery cell due to damage on the outer casing, the following actions are recommended.
- In case of inhalation: Leave the contaminated area immediately and seek medical attention.
- In case of contact with eyes: Rinse eyes with running water for 15 minutes and seek medical attention.
- In case of contact with skin: Wash the contacted area with soap thoroughly and seek medical attention.
- In case of ingestion: Induce vomiting and seek medical attention.



1.6 Qualified Personnel

The installation guide part described herein is intended for use by skilled staff only. A skilled staff is defined as a trained and qualified electrician or installer who has all the following skills and experience:

- Knowledge of battery' specification and properties.
- Knowledge of the installation of electrical devices.
- Knowledge of torsion and screwdrivers for different types of screws.
- Knowledge of local installation standards.
- Electrical license for battery installation required by the country or state.
- Knowledge of the dangers and risks associated with installing and using electrical devices and acceptable mitigation methods.
- Knowledge of and adherence to this guide and all safety precautions and best practices.

For safety reasons, installers are responsible for familiarizing themselves with the contents of this document and all warnings before performing installation and usage.



2 Introduction

The Xtreme HV series is a lithium iron phosphate battery-based energy storage product developed and produced by RENON, it can supply reliable power for nearly all kinds of household appliances and equipment.

The Xtreme HV series consists of a main controller and several battery modules, each battery module has a battery information collection unit, which can monitor cells information including voltage and temperature. The main controller can sense the total voltage and current, communicate with all battery modules, manage and protect the battery.

The Xtreme HV series is very easy to install, and has a well-designed exterior suitable for indoor use.

Supports up to 6 battery modules to extend the energy of a single stack.

2.1 Product features

- The whole product is non-toxic, pollution-free and environment-friendly.
- The battery chemistry is made from LiFePO₄ with safety performance and long cycle life.
- Small volume, plug & play embedded design module, easy to install and maintain.
- Working temperature range between -4 °F to 122 °F (-20 °C to 50 °C) with excellent discharge performance.
- Battery management system (BMS) has protection functions for over-discharge, over-charge, and over-current and high/low temperature.
- The battery has less self-discharge up to 3 months without charging. It has no battery memory effect, excellent performance of shallow charge and discharge.
- The system can automatically manage battery charge and discharge state; and save energy cost by various control strategy.



2.2 Specifications

| Item | R-XH010021 (-H) | R-XH015031 (-H) | R-XH020041 (-H) | R-XH025051 (-H) | R-XH030061 (-H) |
|--|--|-------------------------------|-------------------------------|-------------------------------|-------------------------------|
| Controller Model | R-MC050-XTH01(-H) | | | | |
| Battery Module Model | R-EM102050-XTH01 (-H) | | | | |
| Battery Chemistry | LiFePO4 | | | | |
| Module Quantity | 2 | 3 | 4 | 5 | 6 |
| Nominal Energy (kWh) | 10.24 | 15.36 | 20.48 | 25.60 | 30.72 |
| Nominal Capacity (Ah) | 50 | | | | |
| Max. Charging/Discharging Current (A) | 48 | | | | |
| Nominal Voltage (V) | 204.8 | 307.2 | 409.6 | 512.0 | 614.4 |
| Recommend Charging Voltage (V) | 227.2 | 340.8 | 454.4 | 568.0 | 681.6 |
| Max. Charging Voltage (V) | 233.6 | 350.4 | 467.2 | 584.0 | 700.8 |
| Discharge Cut-off Voltage (V) | 172.8 | 259.2 | 345.6 | 432.0 | 518.4 |
| Heating Film Resistance(Ω) | 56 per module (-H model only) | | | | |
| Heating Start Temperature (°F/°C) | 35/2 (-H model only) | | | | |
| Operation Temperature(°F /°C) | Discharge: -4~122 / -20~50 Charge: 32~122 / 0~50 | | | | |
| Safety Function | Over-charge, Over-discharge, Over-current, Low/High-temperature, Short-circuit Protections | | | | |
| Communication | RS485/CAN/Wi-Fi | | | | |
| Weight (lbs/kg)(Approx.) | 335/152 | 467/212 | 600/272 | 732/332 | 864/392 |
| Physical Dimensions (inches/mm)(W*D*H) | 30.5*10.6*32.6 / 775*270*829 | 30.5*10.6*42.6 / 775*270*1082 | 30.5*10.6*52.5 / 775*270*1334 | 30.5*10.6*62.5 / 775*270*1587 | 30.5*10.6*72.4 / 775*270*1839 |
| Level of Protection | IP65 | | | | |
| Cycle Life | 8000 times @77°F(25°C),0.5C,80%DOD,80%EOL | | | | |
| Designed Calendar Life | 10 years | | | | |



2.3 Interface Information

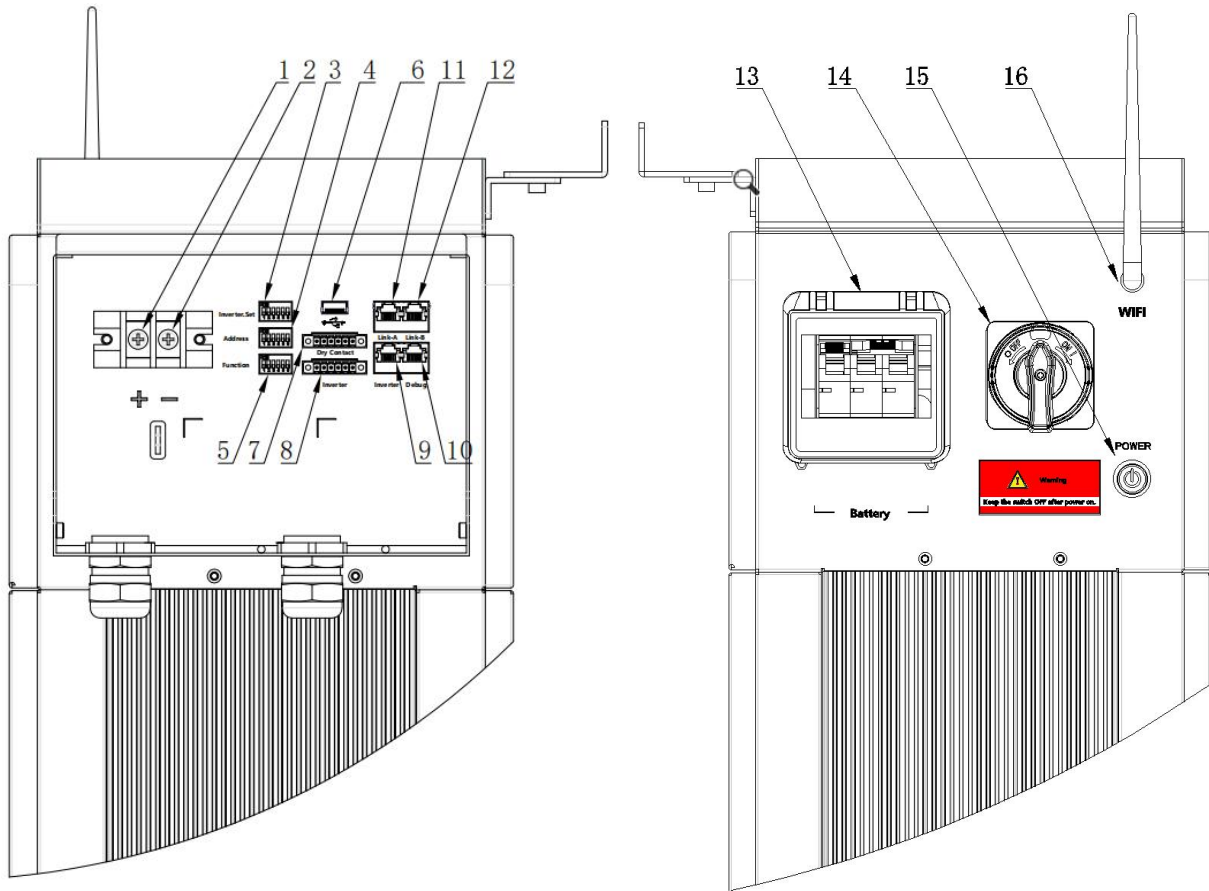

Figure 2.3.1. Interface definition of Controller module

| No. | Instructions | No. | Instructions |
|-----|---|-----|------------------------------------|
| 1 | Power Positive | 9 | Inverter Communication Port (RJ45) |
| 2 | Power Negative | 10 | Debug Port |
| 3 | Inverter Dial Switch | 11 | Link A |
| 4 | Address Dial Switch | 12 | Link B |
| 5 | Function Dial Switch | 13 | Power Switch |
| 6 | USB Port for Upgrade | 14 | Active Switch |
| 7 | Dry Contact | 15 | On/Off |
| 8 | Inverter Communication Port (connector) | 16 | WiFi Antenna |



2.3.1 Power Positive

Terminal type: Terminal for 10mm² power cable

Usage: connect to inverter's positive terminal.

2.3.2 Power Negative

Terminal type: Terminal for 10 mm² power cable

Usage: connect to inverter's negative terminal.

2.3.3 Inverter Dial Switch

Code 0 ~ 32 of this Dial Switch are used to match which brand of inverter is using.

The definitions of code 0 ~ 32 are shown as below table.

| Code | Dial Switch Position | Brand | Logo |
|------|----------------------|-------------------|------|
| 0 | | (Set by software) | |
| 1 | | Sunways | |
| 2 | | Sol-Ark-HV | |
| 3 | | GoodWe-HV | |
| 4 | | Sermatec_HV | |
| 5 | | Invt-HV | |
| 6 | | ThinkPower-HV | |
| 7 | | Koyoe | |
| 8 | | Deye-HV | |
| 9 | | ATESS | |
| 10 | | Solis-HV | |



| | | | |
|----|--|------------|--|
| 11 | | Growatt-HV | |
|----|--|------------|--|

Code 63 is used for special function, defined as below:

| Code | Dial Code Switch Position | Definition |
|------|---------------------------|---|
| 63 | | The battery enters WiFi configuration mode, see chapter 3.7 for more information. |

2.3.4 Address Dial Switch

Use this Dial Switch to set the address of master controller and then turn on to activate the system.

The illustration of dialing as shown below:

| Code | Dial Switch Position | Definition |
|------|----------------------|--|
| 1 | | Set as Cluster 1 (communicate with inverter by this cluster) |

2.3.5 Function Dial Switch

Use this dial switch to match the communication impedance, should set as below:

| Code | Dial Code Switch Position | Definition |
|------|---------------------------|-----------------------------|
| 0 | | When used as single cluster |

Optimize and enhance the communication between the master control unit and the battery.



2.3.6 USB Port

USB Port for firmware upgrade and storage log data, leave it open if not used.

2.3.7 Dry Contact

Terminal type: 6-Pin terminal block

This is for General-purpose output which reserved for future communication and used for an uncommitted digital signal pin on an integrated circuit or electronic circuit (e.g. MCUs/MPUs) board which may be used as an output, and is controllable by software.

Defined as below:

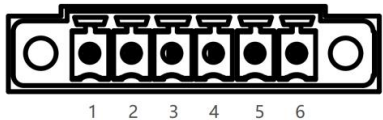
| 6pin Terminal | Pin | Usage |
|--|-----|---------|
|  | 1 | DRY1_NO |
| | 2 | DRY1 |
| | 3 | DRY1_NC |
| | 4 | DRY2_NO |
| | 5 | DRY2 |
| | 6 | DRY2_NC |

2.3.8 Inverter Communication Port (connector)

Terminal type: 6-Pin terminal block

Usage: reserved for direct connection with inverter, same function as the RJ45 port (chapter " **Inverter Communication Port (RJ45)**"), either one of these two will be used.

Defined as below:

| 6pin Terminal | Pin | Usage |
|---|-----|--------------------|
|  | 1 | Inverter.RS485-B |
| | 2 | Inverter.RS485-A |
| | 3 | Inverter.RS485-GND |
| | 4 | Inverter.CANL |
| | 5 | Inverter.CANH |
| | 6 | Inverter.CANGND |



2.3.9 Inverter Communication Port (RJ45)

Terminal type: RJ45

Usage: communicate with inverter, PCS or other equipment.

Installer needs to check the cable pin out before connecting inverter to the battery in order to gain the communication.

For the general information or technical matters in regarding to inverter, please refers to user manual.

Illustration for battery connection port as shown below:

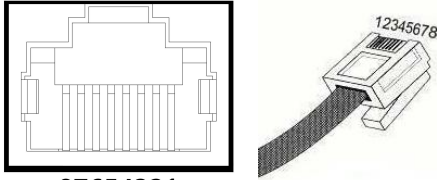
| Port definitions | RJ45 Pin | Function |
|---|----------|--------------------|
|  <p>87654321</p> | 1 | Inverter.RS485-B |
| | 2 | Inverter.RS485-A |
| | 3 | Inverter.RS485-GND |
| | 4 | Inverter.CANGND |
| | 5 | Inverter.CANGND |
| | 6 | Inverter.RS485-GND |
| | 7 | Inverter.CANH |
| | 8 | Inverter.CANL |

2.3.10 Debug Port

Terminal type: RJ45

Usage: debug port of the system which used by technician only.

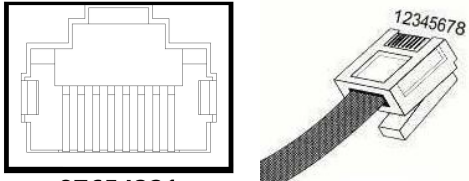
| Port definitions | RJ45 Pin | Function |
|---|----------|-----------------|
|  <p>87654321</p> | 1 | Debug.RS485-B |
| | 2 | Debug.RS485-A |
| | 3 | Debug.RS485-GND |
| | 4 | Debug.CANGND |
| | 5 | Debug.CANGND |
| | 6 | Debug.RS485-GND |



| | | |
|--|---|------------|
| | 7 | Debug.CANH |
| | 8 | Debug.CANL |

2.3.11 Link A and Link B

Link A and Link B is reserved, leave them open.

2.3.12 Power Switch

Power switch: Power on/off the main circuit of the battery.

2.3.13 Active Switch

Twist the switch right to active the main controller circuit, after power on, please twist it to up side, otherwise the output will be disable.

2.3.14 On/Off

Press this button once to power on the system, and press it again to power off.

2.3.15 WIFI Antenna

Connect the WIFI antenna to the port in order to get the APP and WEB Function.



3 Installation and Usage

3.1 Safe Handling Guide

3.1.1 Familiar with the product

Be careful when unpacking the system. Every module of the product is heavy. Don't lift them with a pole. The weight of the modules can be found in the chapter "**Specifications**".

Familiar with batteries. The battery poles are located on the top and bottom sides of the battery module. It's designed of fast mount and foolproof, no need to recognize the positive and negative poles, but take care of them especially the bottom one.

3.1.2 Precautions before installation

Before installation, be sure to read the contents in chapter "**Safety Precautions**", which is related to the operation safety of installation personnel, please pay attention to it.

3.1.3 Tools

The following tools are required to install the product:



Drill



Pencil or marker

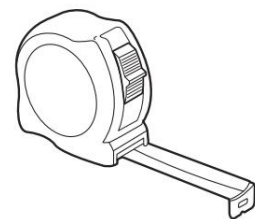

Tape measure



Screwdriver

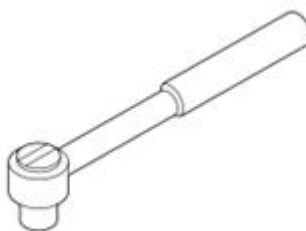

Torque Wrench

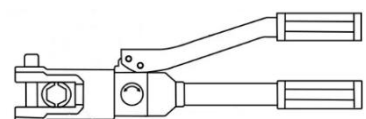

Hydraulic pliers



Use properly insulated tools to prevent accidental electric shock or short circuits. If insulated tools are not available, cover the entire exposed metal surfaces of the available tools, except their tips, with electrical tape.

3.1.4 Safety Gear

It is recommended to wear the following safety gear when dealing with the product:



Insulated gloves



Safety goggles



Safety shoes

3.2 System Premeasurement

The battery required adequate clearance for installation, cabling and airflow. The minimum clearance for system configuration is given below. The cable connecting between battery pack and inverter should be in accordance with the installation guide manual of the inverter.

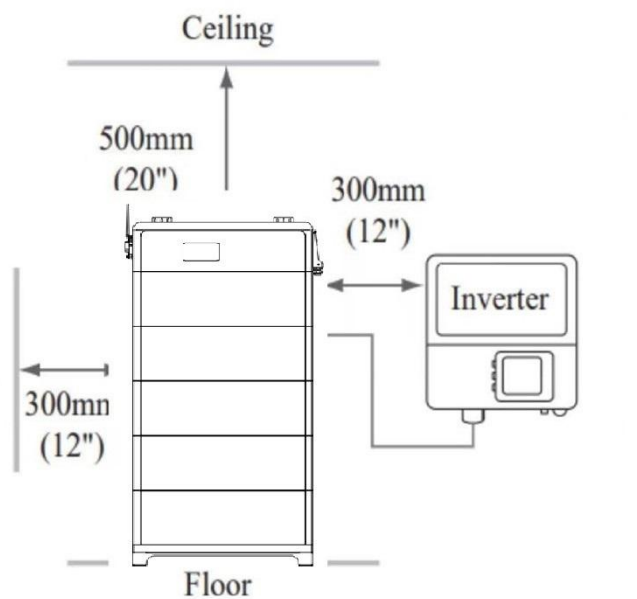

Figure 3.2.1. System clearance



3.3 Installation location

Make sure that the installation location meets the following conditions:

- The floor is flat and level.
- The surface of the wall is smooth and perpendicular to the ground, which can bear the weight.
- The area is completely water proof.
- The area shall avoid direct sunlight.
- There are no flammable or explosive materials.
- The distance from heat source is more than 80inch(2m).
- The ambient temperature is within the range from 32°F(0°C) to 95°F(35°C).
- The humidity is maintained at a constant level.
- There is minimal dust and dirt in the area.
- Avoid installation in an area confined or with high salinity.
- Do not install outside directly.
- Do not place in an area accessible to children or pets.











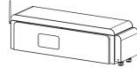

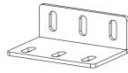

3.4 Package items

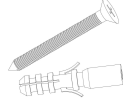
After receiving the product, please unpack the boxes, and check product and packing list first, if product is damaged or lack of parts, please contact with the local retailer.



Here is the Xtreme Series Packing List:





(1) Main controller:

| No. | Item | Specification | Qty | Usage | Diagram |
|-----|-------------------------------------|---|-----|--|---|
| 1 | Main controller | 32.3*10.6*9inches /820*270*229mm | 1 | Controller of the battery cluster |  |
| 2 | Base | 30.5*9.4*4.8inches /775*238*121.5mm | 1 | Bottom base of the battery cluster |  |
| 3 | Mounting bracket A | 3.1*2.2*2.2inches /80*55*55mm | 2 | Mounted at the rear of the controller, used to stabilize the cluster |  |
| 4 | Mounting bracket B | 3.1*1.6*0.9inches /80*40*22mm | 2 | Combine the mounting bracket A to wall, used to stabilize the cluster |  |
| 5 | Screw | Stainless steel M4*12 triple combination | 12 | Fasten mounting bracket A to controller, fix the side panel connector to the bottom base |  |
| 6 | Screw | Stainless steel M5*12 triple combination | 6 | Fasten mounting bracket B to A |  |
| 7 | Screw | Stainless steel M4*8 | 4 | Side plate fixing screws |  |
| 8 | Screw | Plastic expansion screw 10*60 | 6 | Fasten mounting bracket B to wall |  |
| 9 | Screw | Stainless steel expansion screw M8*80 | 4 | Fasten base to floor |  |
| 10 | WIFI antenna | 2.4GHz L-type | 1 | Connect with internet |  |
| 11 | User manual | Xtreme HV series | 1 | User manual |  |
| 12 | Positive power cable (customizable) | Red, 6AWG, with RNB14-6S terminals on both side, 1.5m | 1 | Connect positive pole of battery and inverter |  |
| 13 | Negative power cable (customizable) | Black, 6AWG, with RNB14-6S terminals on both side, 1.5m | 1 | Connect negative pole of battery and inverter |  |
| 14 | Communication cable(optional) | Standard RJ45 network cable, 1m | 2 | Connect the communication pole of battery and inverter |  |
| 15 | Pin order select box (optional) | 3.3*1.0*0.9inches /85*26*22mm | 1 | Set the pin order of the communication cable of |  |



| | | | | | |
|----|-------------------------|-----------------------------------|---|---|---|
| | | | | battery and inverter, cooperate with 2 standard network cable | |
| 16 | Allen key | M4 | 1 | Tighten the screws on the side cover of the main controller |  |
| 17 | Side panel connector | 1.3*0.6*0.1inches/ 32*14*1.5mm | 4 | Connect the side panel |  |

(2) Battery module:

| No. | Item | Specification | Qty | Usage | Diagram |
|-----|-------------------|--|-----|----------------------------|---|
| 1 | Battery module | 30.5*10.6*11inches /775*270*279mm | 1 | Storage of cells |  |
| 2 | Screw | M4*12 screws with collar | 4 | Side plate fixing screws |  |
| 3 | Side plate | 10.4*6.5*0.2inches /264.8*164*4.5mm | 2 | To fix the battery modules |  |



3.5 Installation

1) Preparation of master controller: Fastened 2 mounting brackets A to the top back of the controller and screw those properly.

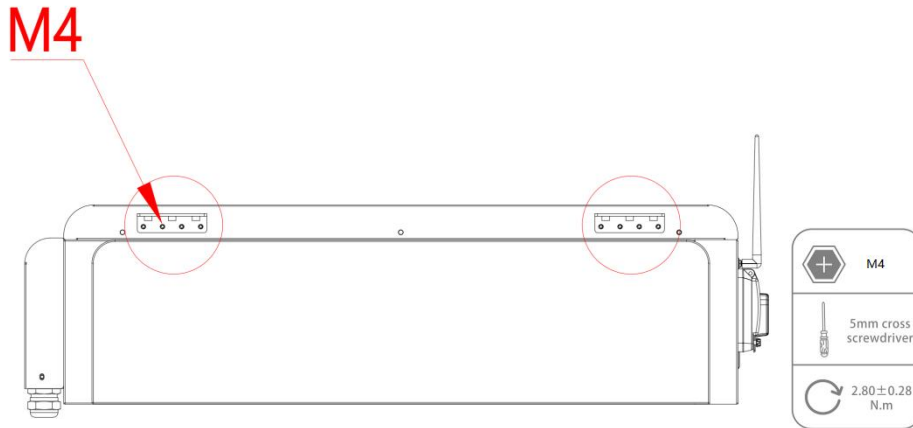

Figure 3.5.1. Fastened the mounting bracket A

Preparation of the controller module: Fastened 2 mounting brackets B to mounting bracket A and screw those properly.

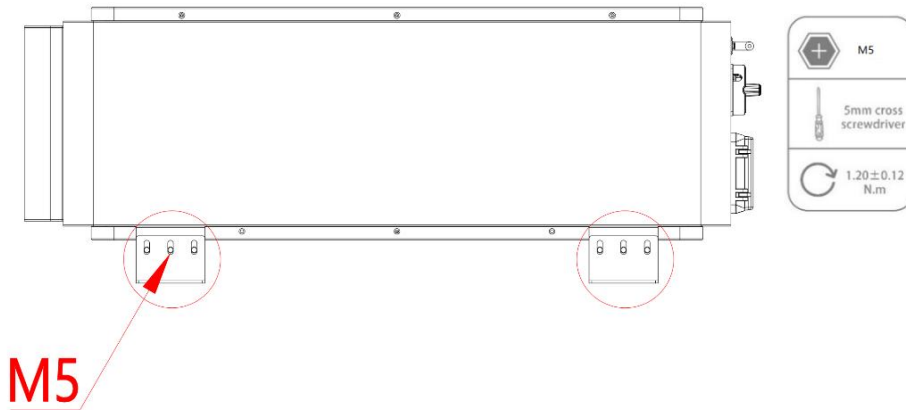

Figure 3.5.2. Fastened the mounting bracket B

2) Place the base on the floor be close to the wall 2.08inches (53mm), the connector of the base should be placed at the left side.

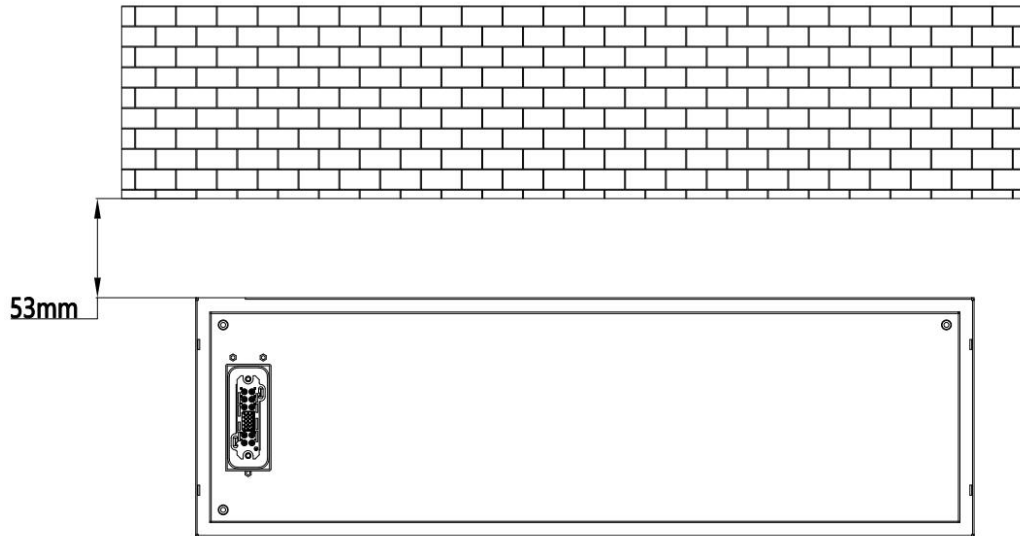

Figure 3.5.3. Put the base on the floor

- 3) Fasten the 4 mounting holes of the base on the floor in a stable condition.

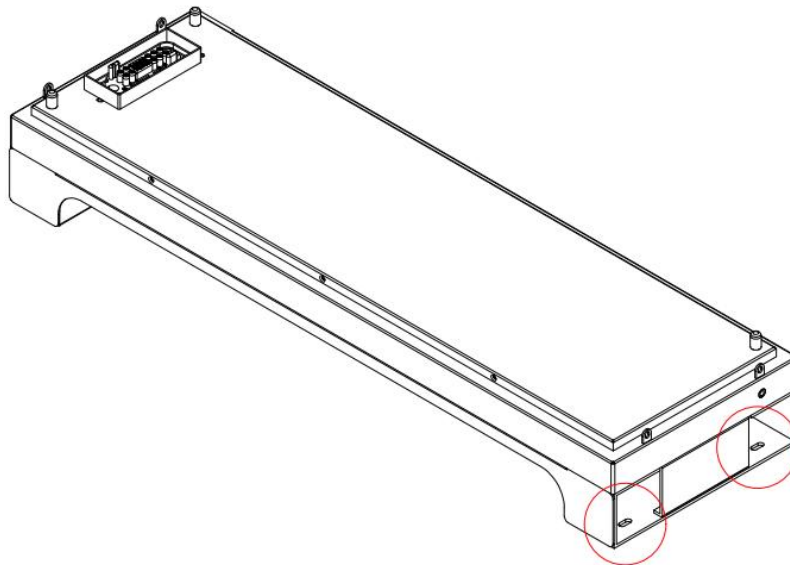

Figure 3.5.4. Mounting holes of the base

- 4) Stack up the battery modules, and then place the master controller unit on the top finally. There are protective patches on both top and bottom of the connectors, please tear off them before stack.

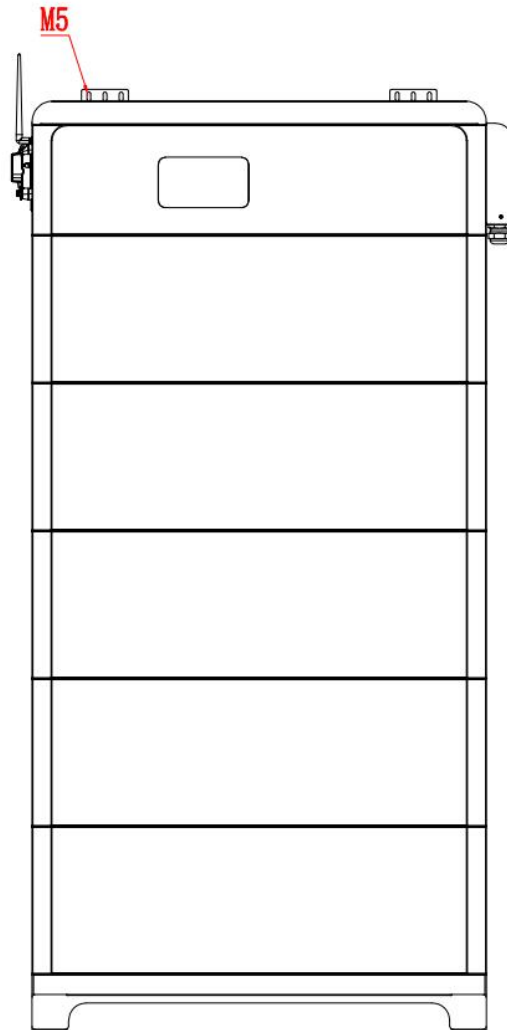

Figure 3.5.5. Stacked product (5 modules)



5) Fasten the 6 mounting holes of the mounting bracket B on the wall in a stable condition.

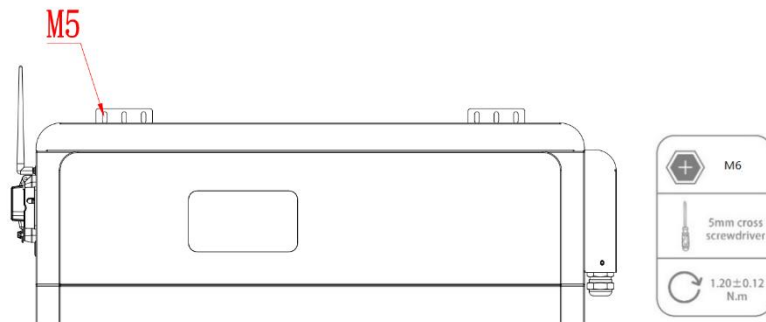

Figure 3.5.6. Mounting holes of the base

6) Install the side panel connector between the bottom battery module and the base via 8 screws in each battery cluster.

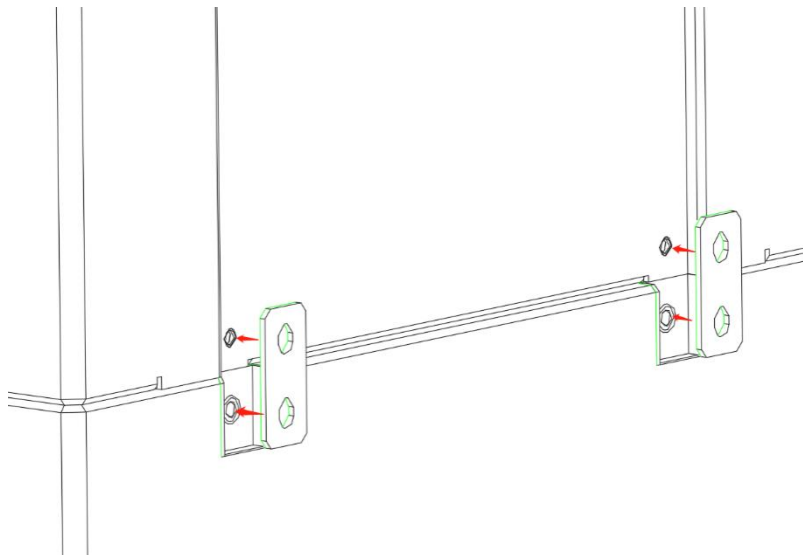

Figure 3.5.7. Mounting side panel connector

7) Screw the groove plate to the side of each battery modules and make sure it is attached to the side and screw properly.

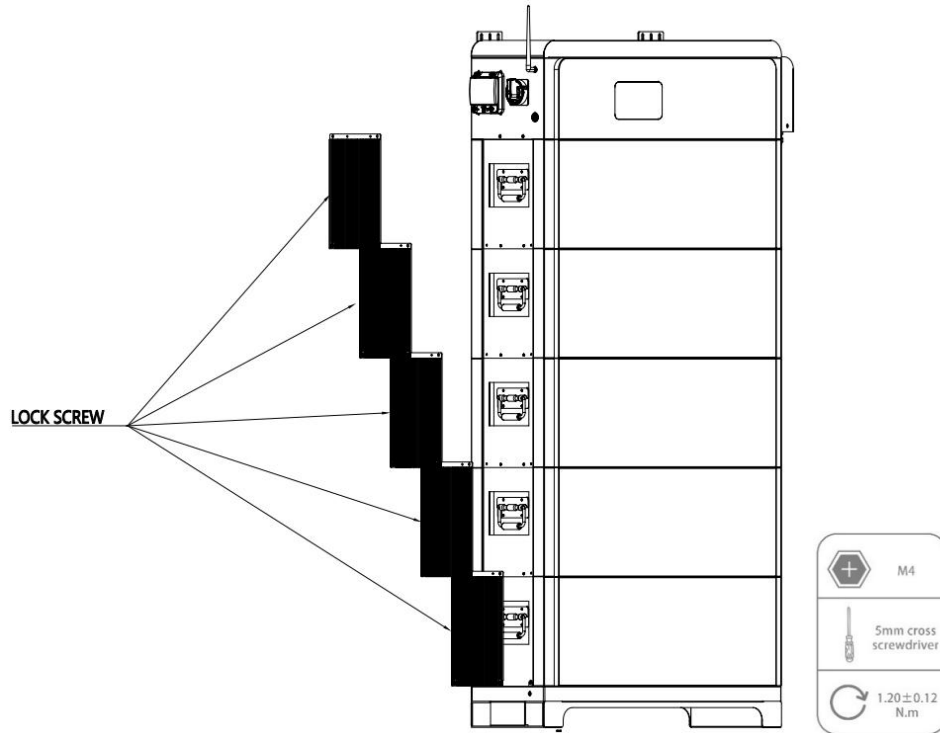

Figure 3.5.8. Installation Diagram of the mounting brackets

8) Connect the ground wire as the diagram shown below.

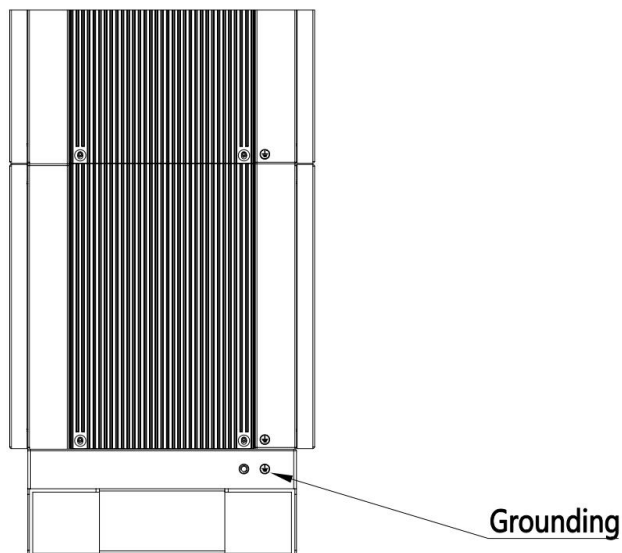

Figure 3.5.9. Ground wire connection

3.6 Connections of Cable and Power

1) Remove the side cover case.

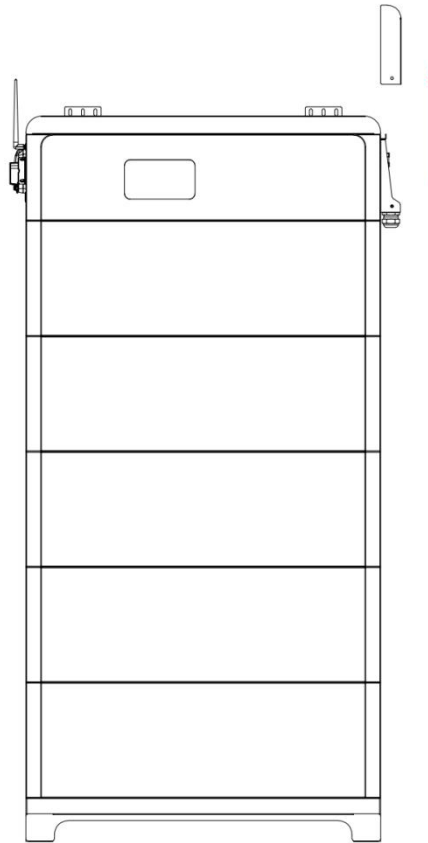

Figure 3.6.1. Removal position of the battery control module

2) Set the Address dial code as 1 and set the function dial code as 0 in binary formation.

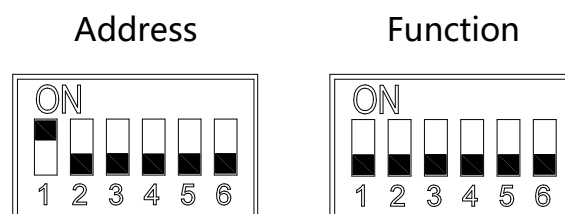

Figure 3.6.2. Dial code

- 3) Remove the cover of the positive and the negative electrode. Connect the battery positive and negative electrode with the inverter's positive and negative electrode separately.
- 4) Connect CAN/RS485 wire to the inverter port of the master controller and inverter's CAN/RS485 port.



If you are using the pin order select box, please refer to the table below to set the dial switch, according to the inverter brand. If the inverter brand is not shown in the table, please refer to the inverter manual or consult Renon's engineer.

| Dial switch position | Inverter brand |
|---|--|
| <p style="text-align: center;">CAN RS485</p> | <p>Sol-Ark, Solis, Deye, GoodWe, Sermatec, INVT, Koyoe, Sunways, Thinkpower, Growatt</p> |

5) Cross the power cable trough the black rubber.

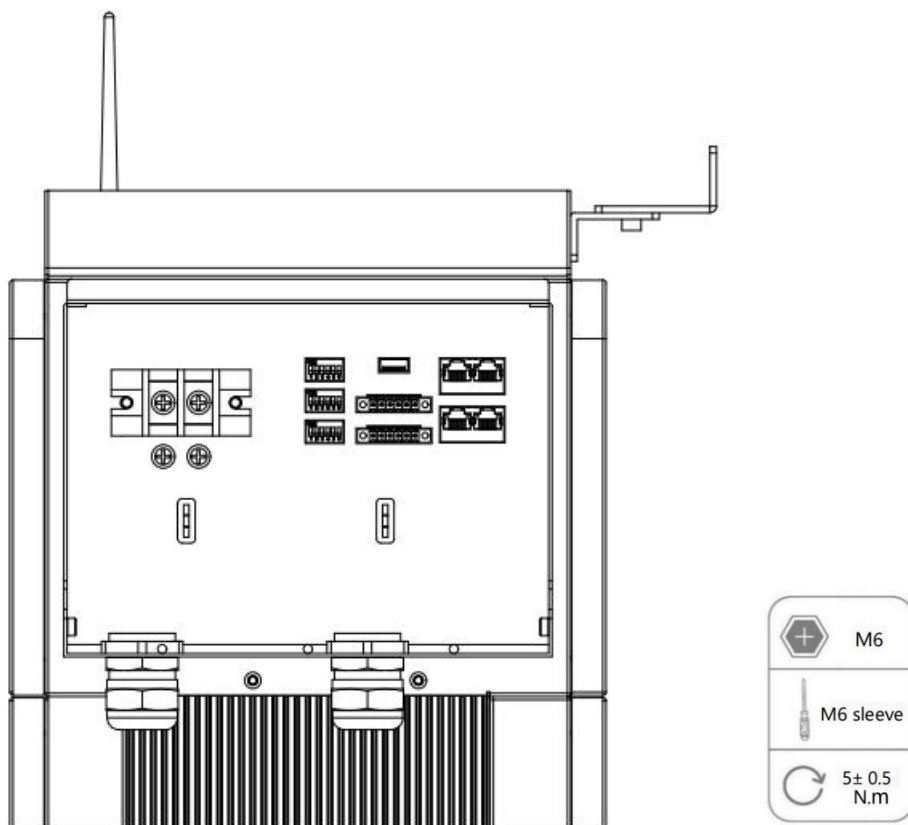
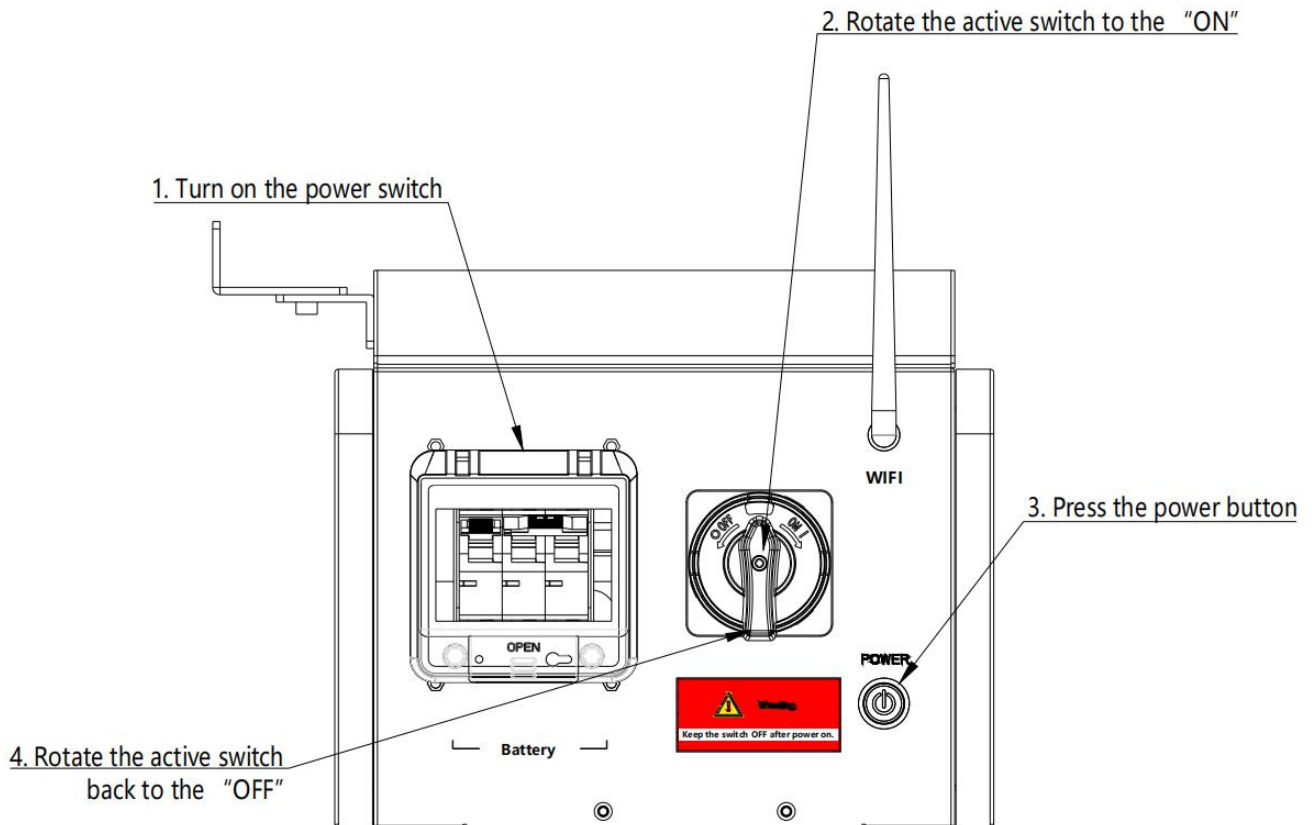

Figure 3.6.3. Power line connection

6) Please turn on the DC breaker of the inverter if it has one, then turn on the power switch, rotate the active switch to the "ON" position, press the power button, wait for the beeper sound occurred, and then rotate the active switch back to the "OFF" position.



7) Set the inverter dial code to the corresponding inverter's code.

8) Check the screen to make sure the number of battery modules is showing correctly without any alarm.



3.7 Wi-Fi Configuration

Screw the antenna into the antenna connection port firmly before Wi-Fi configuration.

Set the inverter dial code (**INV SET**) to code 63(111111) as shown below before Wi-Fi configuration.

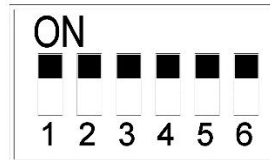

Figure 3.7.1. INV SET code 63

- 1) Download and install RENON APP from Google or Apple Store by searching "Renon Smart" .

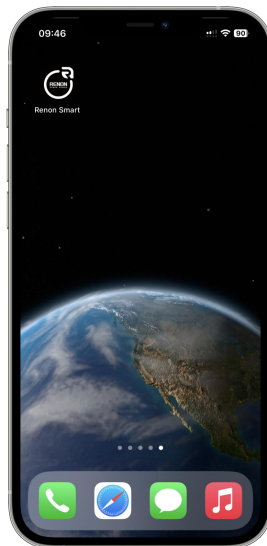

Figure 3.7.2. Install RENON APP

- 2) You may acquire the Register Code from your installer for new account registration. If you already had an account, you may use it to login the APP directly otherwise you need to create an account.

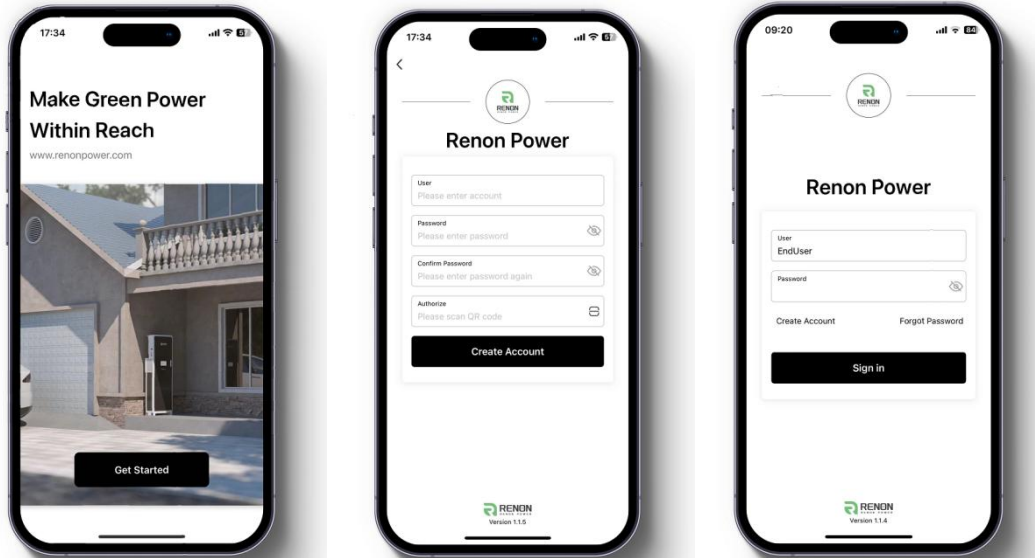

Figure 3.7.3. Start the APP & Create an account & Sign in

- 3) Turn to the page account then click the Network, following by the instruction of network setting for WIFI configuration.

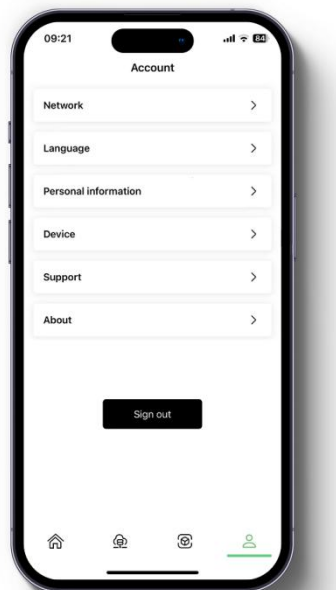

Figure 3.7.4. Network Setting

- 4) Connect your mobile phone to the WI-FI hotspot from the master controller which SSID is same as controller's serial number (SN) and the password is 12345678.

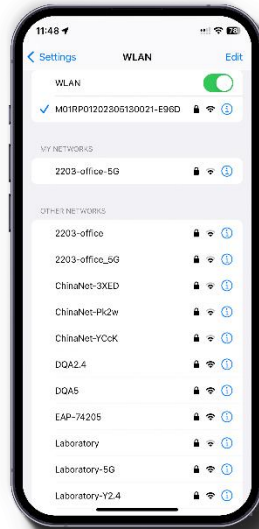

Figure 3.7.5. Connecting WIFI Hotspot of Product

- 5) Enter the SSID and password of your private WI-FI for connecting master controller to your private WI-FI. Make sure the Wi-Fi symbol on screen will shine constantly, and change the inverter dial switch back to the code you need.

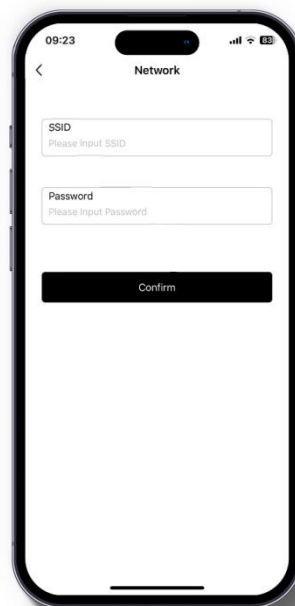

Figure 3.7.6. Connecting Private WIFI

- 6) Ask your installer to assign all your products to your account.
- 7) Turn to main page of the APP, create a plant, and set a recognizable name, your email and address for it.

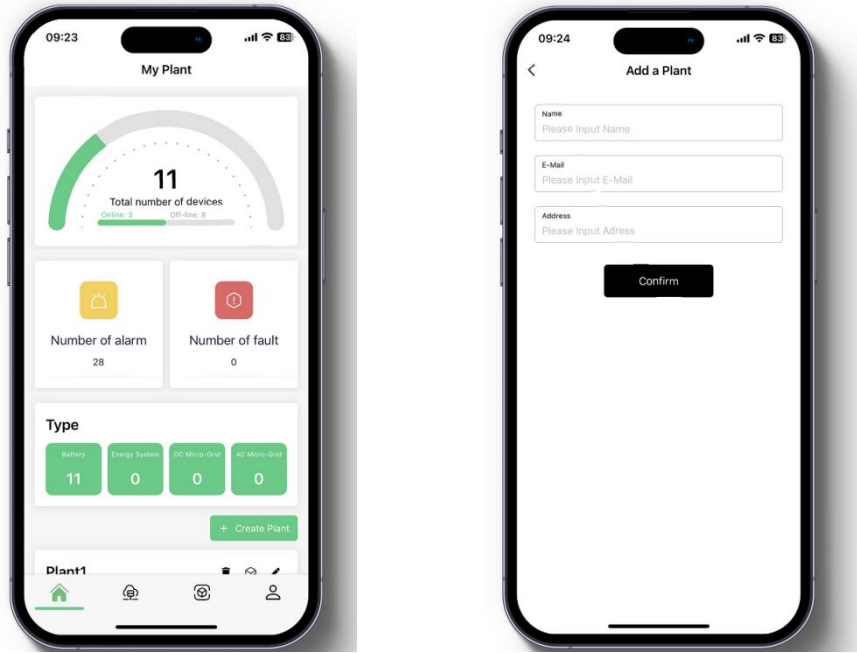

Figure 3.7.7. Create A New Plant

- 8) Click the confirm button to create your plant and all your products will show up as their SN, select proper products and confirm.

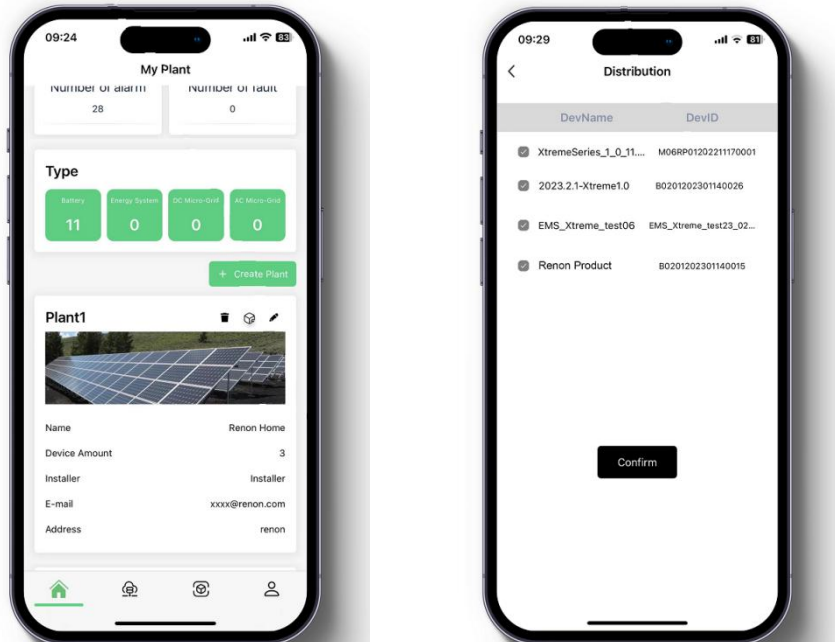

Figure 3.7.8. Manage Your Plant & Confirm Your Products

- 9) Now you can manage your products in the APP, and you can also manage them in Website, ask your installer for the site URL.

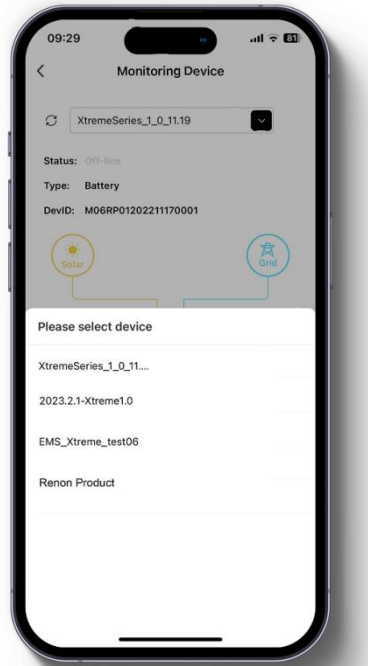

Figure 3.7.9. Manage Your Products

10) After the product is connected to Wi-Fi, the running status, real-time power, daily power consumption and cumulative power of the product can be monitored in real time on the network platform or mobile APP. It can also be used to configure parameters.

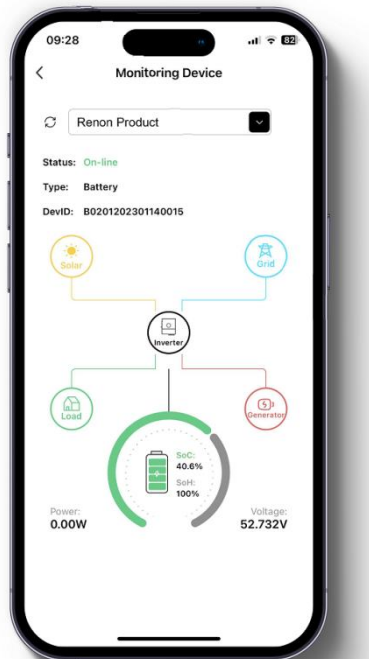

Figure 3.7.10. Monitoring Device



4 Monitoring Screen

4.1 LCD Screen Introduction

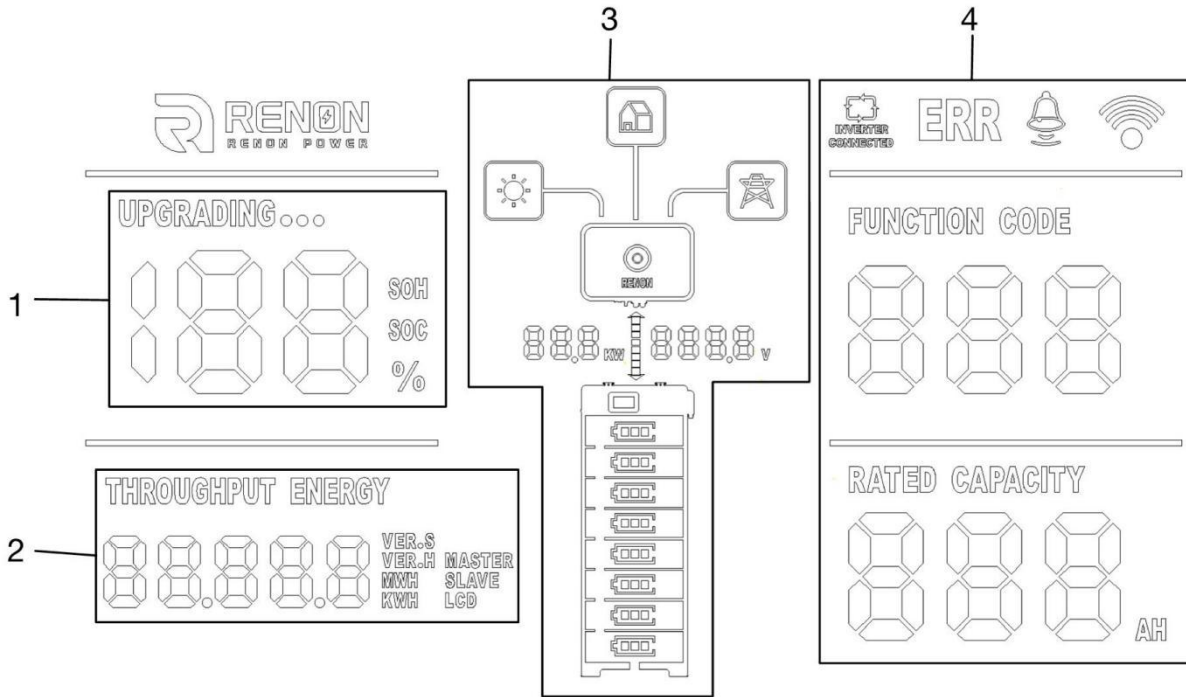

Figure 4.1 LCD Screen Introduction

5

| No. | Instructions |
|-----|--|
| 1 | SOC, SOH and Upgrading State |
| 2 | Version and Accumulated Discharge Energy |
| 3 | ESS status, Power, and Voltage |
| 4 | Battery Operation State |

4.2 SOC, SOH and Upgrading State

- 1) The percent number displays current SOC when underneath SOC sign lights on and current SOH when underneath SOH blinking lights on, respectively. The SOC will light up 60s and then SOH light up 3s in a display cycle.
- 2) The "UPGRADING..." sign will show up when the battery is in the upgrade. The percentage indicates the progress of the upgrade.



4.3 Version and Accumulated Discharge Energy

The number shows version of software and hardware for LCD, master, and slave, accumulated discharged energy counted in kWh or MWh, respectively. Each part will keep showing on for 3 seconds and then switch to next.

4.4 ESS status, Power, and Voltage

- 1) The number displays current power and volage of whole battery stacks. Direction of the arrow between those two numbers indicates it`s charging or discharging.
- 2) Battery modules sign will indicate the number of battery modules. Online modules will have lights on constantly whether offline modules will have blink periodically.

4.5 Battery Operation Status

1) Indication Code

If there is any error or warning sign, the Indication code will show up. When the Indication code shows on with "ERR" , it means there are some errors occurred. The Indication code shows up with "🔔" is warning reminder. When there is no warning nor error, the function code will show as 0.

2) Inverter Connection

"INVERTER CONNECTION" sign indicates the status of connection between inverter and battery. It will show on when the connection is proper. Otherwise, it will be off. Some inverters do not feedback signal to battery, this symbol may always off.

3) Wi-Fi Connection Symbol

The symbol will show on constantly when Wi-Fi connection is good. It will shine periodically when the WIFI configured for the battery cannot connect to the server. Off means the battery is waiting for Wi-Fi configuration.

4) Rated Capacity

Rated Capacity indicates the nominal capacity of current cluster.





5 Troubleshooting & Maintenance

5.1 Regular maintenance

- 1) Check the battery modules every 3 months to verify whether there are damages.
- 2) Check the battery modules every 3 months to verify whether the operating parameter is normal or there is no abnormal heating.
- 3) Fully charge and discharge the battery system every 3 months.
- 4) Clean the battery modules with a dry rag once a month.

5.2 Troubleshooting

| Phenomenon | Investigation & troubleshooting |
|--|--|
| The number of battery module symbol is incorrect.  | <ol style="list-style-type: none"> 1. Make sure the whole battery system being stacked neatly. 2. Try to restart the battery system. |
| The symbol of battery modules on the screen is blinking (frequency of 1s)  | <ol style="list-style-type: none"> 1. Make sure the whole battery system being stacked neatly. 2. Make sure the function dial switch code setting is correct, please refer to chapter "function dial switch" . 3. Try to restart the battery system. |
| Unable to turn on the battery | <ol style="list-style-type: none"> 1. Try to charge the battery by the activation charging function of the inverter when power is on. |
| Unable to find the battery on the APP & the Cloud | <ol style="list-style-type: none"> 1. Make sure the antenna is screwed properly. 2. Make sure the WIFI configuration is correct. 3. Make sure the SSID & PASSWORD of your private WIFI is correct, please enter information case-sensitively without space. 4. Make sure the frequency of the WIFI connected to the product is not 5GHz (2.4GHz and 2.4GHz / 5GHz is acceptable). 5. Make sure the WIFI signal is strong enough. 6. Make sure WIFI is working. 7. Make sure installer is distributed your products on user's account. |



| | |
|---|---|
| | <ol style="list-style-type: none"> 8. Try to restart the WIFI router. |
| <p>No output after power on.</p> | <ol style="list-style-type: none"> 1. Make sure the address dial code setting is correct, refer to the chapter of address dial code. 2. Make sure SOC is not 0% otherwise charge battery please. 3. Make sure the activate switch is rotate to "OFF" (upside). |
| <p>Unable to communicate with inverter</p> | <ol style="list-style-type: none"> 1. Make sure the connection of communication cable and power cable is correct, refer to the chapter of connection of cable and power. 2. Make sure the address dial code of the master controller connected to inverter is 1. 3. Make sure the inverter dial code of the master controller connected to inverter is correct, refer to the chapter of inverter dial code. 4. If you are using a pin order select box, please verify that the dialing switch is configured correctly. |
| <p>Unable to be charged by inverter</p> | <ol style="list-style-type: none"> 1. Make sure power cable connection is correct. 2. Check whether inverter has faults. 3. Check whether grid or PV is available. 4. Make sure Time of Use of the inverter setting is correct. 5. Make sure charging voltage and charging current setting of the inverter match the parameters of the battery. 6. Check the battery low or high temperature protection alarm. 7. Check the over current protection alarm. 8. Make sure the SOC value is below 96% (default value). |
| <p>Unable to discharge while SOC is not zero.</p> | <ol style="list-style-type: none"> 1. Make sure the connection of cables is correct and circuit breaker is ON. 2. Check whether inverter has faults. 3. Make sure the inverter setting is not back up mode. 4. Check whether SOC is lower than the shutdown value of the inverter. 5. Check the battery low or high temperature protection alarm. 6. Check the over current protection alarm. |



| | |
|------------------------------------|--|
| SOC value change instantly. | 1. It is normal that the SOC value will be calibrated when the battery is been full charged or deep discharged. |
| Error or Alarm shown on the screen | 1. Check the battery refer to the definition of the error or warning codes. If cannot solve the problem, please contact the installer. |

5.3 Warning Codes

Warning Code (Sign like “🔔”)

| Code | Warning type | Investigation & troubleshooting |
|------|--|---|
| 1 | Low cell voltage discharge protection | 1. Low voltage level and needs to be charged |
| 2 | Overcurrent charge protection | 1. Restore to factory setting. 2. Make sure the inverter’s setting of max current do not excess the max charge current of the battery. |
| 3 | Overcurrent discharge protection | 1. Make sure the power of load do not exceed the power of battery. |
| 4 | Over temp charge protection | 1. Make sure the battery’s temperature shown on the inverter or the APP is below 55°C, otherwise turn off the battery till the temperature is below 55°C and then try to charge battery. |
| 5 | Over temp discharge protection | 1. Make sure the battery’s temperature shown on the inverter or the APP is below 55°C, otherwise turn off the battery till the temperature is below 55°C and then try to discharge battery. |
| 6 | Low temp charge protection | 1. Make sure the battery’s temperature shown on the inverter or the APP is above 0°C, otherwise turn off the battery till the temperature is above 0°C and then try to charge battery. |
| 7 | Low temp discharge protection | 1. Make sure the battery’s temperature shown on the inverter or the APP is above -20°C, otherwise turn off the battery till the temperature is above -20°C and then try to charge battery. |
| 8 | High ambient temp protection | 1. Make sure the ambient temperature of the battery is below 50°C. |
| 9 | Cell voltage off-set protection | 1. Restart the battery and see if the warning code 9 still remaining contact your installer. |
| 10 | High relay temp protection | 1. Restart the battery and see if the warning code 10 still remaining contact your installer. |
| 11 | Busbar high temp protection | 1. Restart the battery and see if the warning code 11 still remaining contact your installer. |
| 13 | Low battery voltage Discharge protection | 1. Need to be charged |



| | | |
|----|-----------------------------|---|
| 14 | Low ambient temp protection | 1. Make sure the ambient temperature of the battery is above -25°C. |
| 15 | High MOS temp protection | 1. Reduce the ambient temperature and restart the battery. |

5.4 Error Codes

Error Code (Sign like "ERR")

| Code | Error Type | Investigation & troubleshooting |
|------|---|---|
| 100 | Discharge relay fault | 1. Restart the battery, and if the error code 100 still remaining or reappear, contact your installer. |
| 101 | Charge relay fault | 1. Restart the battery, and if the error code 101 still remaining or reappear, contact your installer. |
| 102 | Cell failure | 1. Restart the battery, and if the error code 102 still remaining or reappear, contact your installer. |
| 103 | Temperature sensor malfunction | 1. Restart the battery, and if the error code 103 still remaining or reappear, contact your installer. |
| 104 | Current sensor malfunction | 1. Restart the battery, and if the error code 104 still remaining or reappear, contact your installer. |
| 105 | Battery module lost communication with controller | 1. Check whether the address and function dial switch are set according to the user manual. 2. Restart the battery, and if the error code 105 still remaining or reappear, contact your installer. |
| 106 | Short circuit detected | 1. Make sure the external connection for both battery and inverters are proper. 2. Disconnect all external connections and restart the battery, and if the error code 106 still remaining or reappear, contact your installer. |
| 107 | Battery total voltage sensor malfunction | 1. Restart the battery, and if the error code 107 still remaining or reappear, contact your installer. |
| 108 | Heating function failure | 1. Restart the battery, and if the error code 108 still remaining or reappear, contact your installer. |
| 109 | Battery module address conflict | 1. Check whether the function dial switch is set according to the user manual. 2. Restart the battery, and if the error code 109 still remaining or reappear, contact your installer. |
| 110 | Main controller address conflict | 1. Check whether the address and function dial switch are set according to the user manual. 2. Restart the battery, and if the error code 110 still remaining or reappear, contact your installer. |
| 111 | Charge MOS malfunction | 1. Restart the battery, and if the error code 111 still remaining or reappear, contact your installer. |
| 112 | Discharge MOS malfunction | 1. Restart the battery, and if the error code 112 still remaining or reappear, contact your installer. |



| | | |
|-----|--|---|
| 113 | Addressing failure | <ol style="list-style-type: none"> 1. Check whether the address and function dial switch are set according to the user manual. 2. Restart the battery, and if the error code 113 still remaining or reappear, contact your installer. |
| 114 | Pre-discharging fault | <ol style="list-style-type: none"> 1. Make sure the external connection for both battery and inverters are proper. 2. Disconnect all external connections and restart the battery, and if the error code 114 still remaining or reappear, contact your installer. |
| 115 | Cluster communication failure | <ol style="list-style-type: none"> 1. Check whether the address switch is set according to the user manual. 2. Restart the battery, and if the error code 115 still remaining or reappear, contact your installer. |
| 116 | Battery backconnection failure | <ol style="list-style-type: none"> 1. Restart the battery, and if the error code 116 still remaining or reappear, contact your installer. |
| 117 | External total voltage check fault | <ol style="list-style-type: none"> 1. Restart the battery, and if the error code 117 still remaining or reappear, contact your installer. |
| 118 | Address not 1 for single battery | <ol style="list-style-type: none"> 1. Check whether the function dial switch is set according to the user manual. 2. Restart the battery, and if the error code 118 still remaining or reappear, contact your installer. |
| 119 | Addresses are discontinuous | <ol style="list-style-type: none"> 1. Check whether the function dial switch is set according to the user manual. 2. Restart the battery, and if the error code 119 still remaining or reappear, contact your installer. |
| 120 | Master controller communication fault | <ol style="list-style-type: none"> 1. Check whether the function dial switch is set according to the user manual. 2. Restart the battery, and if the error code 120 still remaining or reappear, contact your installer. |
| 200 | Low cell voltage discharge safety lock | <ol style="list-style-type: none"> 1. Restart the battery, and if the error code 200 still remaining or reappear, contact your installer. |
| 201 | High cell voltage charge safety lock | <ol style="list-style-type: none"> 1. Restart the battery, and if the error code 201 still remaining or reappear, contact your installer. |
| 202 | Over temp charge safety lock | <ol style="list-style-type: none"> 1. Restart the battery, and if the error code 202 still remaining or reappear, contact your installer. |
| 203 | Low temp charge safety lock | <ol style="list-style-type: none"> 1. Restart the battery, and if the error code 203 still remaining or reappear, contact your installer. |
| 204 | Over temp discharge safety lock | <ol style="list-style-type: none"> 1. Restart the battery, and if the error code 204 still remaining or reappear, contact your installer. |
| 205 | Low temp discharge safety lock | <ol style="list-style-type: none"> 1. Restart the battery, and if the error code 205 still remaining or reappear, contact your installer. |
| 206 | Overcurrent charge safety lock | <ol style="list-style-type: none"> 1. Restart the battery, and if the error code 206 still remaining or reappear, contact your installer. |
| 207 | Overcurrent discharge safety lock | <ol style="list-style-type: none"> 1. Restart the battery, and if the error code 207 still remaining or reappear, contact your installer. |